

FR Bonde *HYGIENE+*

NL *HYGIENE+* afvoerplug

EN *HYGIENE+* waste

ES Desagüe *HYGIENE+*

DE Ablaufventil *HYGIENE+*

PT Válvula *HYGIENE+*

PL Korek *HYGIENE+*

RU Пешемка *HYGIENE+*

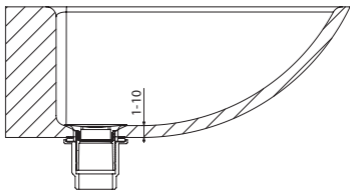
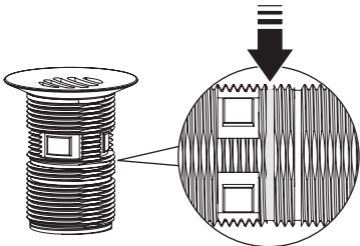

A**A1**

A2

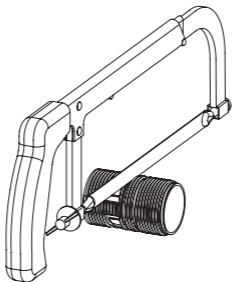

A3

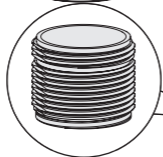
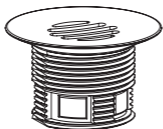

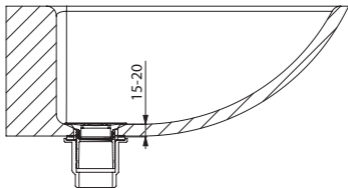
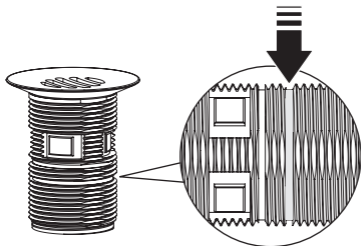
B**B1**

B2

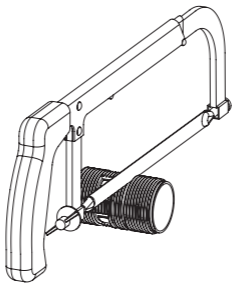

B3

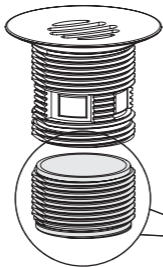

c

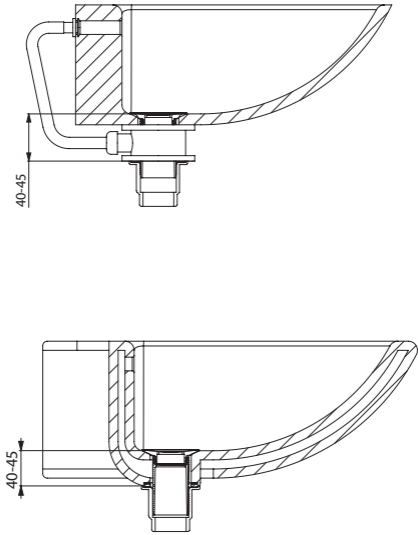

D

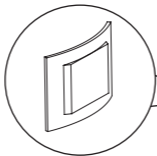
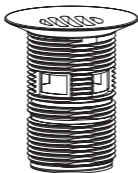
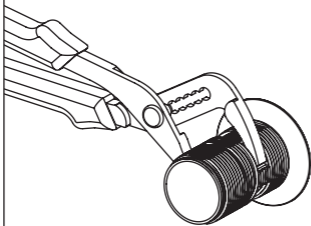

E

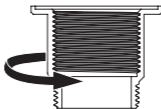
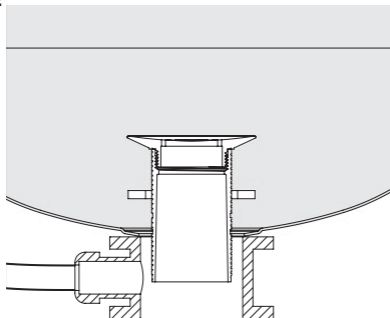

AQUATOOLS
infection control solutions

26, rue Charles-Édouard Jeanneret
78300 Poissy - France
Tél. : +33 (0)1 39 75 02 20